



**Generating Set  
SUPERSILENT - Diesel**

**GE.BD.065/060.SS+011**

1500 rpm - Threephase - 50Hz - 400V  
Automatic panel without switching on board



Image for demonstration purposes

## Standard equipment

### ⚙️ Canopy Soundproofing

Removable soundproof canopy  
Painting canopy (RAL) in galvanized sheet steel  
Soundproofing with class 1 polyester material  
Handles with key lock and automatic closing  
Special baffles for air intake and air expulsion  
Inspection doors for controls and maintenance

### ⚙️ Exhaust

Exhaust rain cap  
Insulated exhaust pipes  
Internal residential muffler - 35dB(A)

### ⚙️ Fuel Supply

Single wall daily tank with bunded base  
Automatic shutdown system for low fuel level  
Fuel gauge

### ⚙️ Handling

Lifting hook integrated into the bearing structure  
Base frame with anti-overturning forklift pockets  
forkliftable on the short side

### ⚙️ Base Frame

Bunded base at 110% of fuel tank capacity  
Anti-vibrating mounting pads  
Battery compartment externally accessible for easy service

### ⚙️ Engine

High coolant temperature and low oil pressure shutdown system  
External oil drain points  
Engine liquids (oil and antifreeze)  
Tropicalized radiator  
Rotating parts protection  
Electronic speed governor

### ⚙️ Alternator

AVR Automatic Voltage Regulator  
Impregnation for marine environment  
IP23

### ⚙️ Panel & connection

Emergency Stop button  
Non-Automatic circuit breaker on panel board  
RCD with adjustable current and excludible  
Tamperproof panel IP55  
Cable output from the bottom  
IP44 wiring  
Start-up battery (pre-charged)  
Grounding point

### ⚙️ Documentation

CE conformity declaration  
User and Maintenance manual  
Wirings diagrams

### ⚙️ Normatives

All Generating sets are compliant to CE Marking  
2014/30/UE Electromagnetic compatibility  
2000/14/CE Noise Emission for outdoor use  
Factory-designed systems built according to ISO 9001:2015  
CEI EN 60204-1:2018 - Electrical equipment of machines

## Primary data

### General Information

Speed	RPM	1500
Frequency	Hz	50
PRP	KVA	60
PRP - Prime power	KW	48,0
LTP - Standby power	KVA	66
LTP - Standby power	KW	52,8
Standard Voltage	V	400/230
Current	A	86,71
Voltage for current calculation	V	400
COSFI	0,8	0,8

### General electrical protection

Circuit-breaker rated current	A	100
Type	Non-Automatic circuit breaker on panel board	
Circuit-breaker poles	N	4P
Optional/notes circuit-breaker	Opening coil	
Additional protection	Adjustable and excludable Differential protection	
Protection device	Control module	
Adjustments tripping set-point (I <sub>d</sub> )	mA	30 - 5000
Adjustments tripping time (t)	sec.	0 - 30

### Noise level +/- 3dB(A)

LWA	dB(A)	92
Sound pressure level @ 7 mt	dB(A)	67
Sound pressure level @ 1 mt	dB(A)	76

### Fuel Consumption

TYPE	Diesel	
Standard Fuel Tank capacity	lt	250
Autonomy @ 75% load	h	23
Fuel consumption at 100% load	lt/h	14,6
Fuel consumption at 75% load	lt/h	11
Fuel consumption at 50% load	lt/h	7,8

### General data

Rated capacity	Ah	1x120
Auxiliary Voltage	V	12
Exhaust gas temperature	°C	550
Exhaust gas flow	l/s	161
Combustion air flow	l/s	67
Cooling fan airflow	mc/s	2,4
Exhaust diameter	mm	80

## Weight and Dimensions

Dimensions (L x w x h)	cm	<b>260x110x168</b>
Weight with liquids (excluding optionals and fuel)	Kg (+/-3%)	<b>1462</b>

## Engine

Factory		<b>Baudouin</b>
Model		<b>4M11G70/5</b>
Emissions stage		<b>Stage 0</b>
Speed governor		<b>Electronic</b>
Radiator	°C	<b>50</b>
Cooling	Tipo	<b>liquid (water + 50% Paraflu11)</b>
Active net power	Kwm	<b>57,3</b>
Nominal net power	CV	<b>77,9</b>
Cycle	Tipo	<b>4 strokes</b>
Aspiration	Tipo	<b>Turbo</b>
Numbers of cylinders	N	<b>4</b>
Cylinders arrangement		<b>L</b>
Bore	mm	<b>105</b>
Stroke	mm	<b>130</b>
Total displacement	lt	<b>4,5</b>
Engine oil features		<b>15W40-API CI-4/CH-4 ACEA E5-E7</b>
Total oil capacity	lt	<b>13</b>
Total coolant capacity	lt	<b>17</b>
ISO 8528-5 class		<b>G2</b>

## Alternator

**\* May vary based on stock availability. However, a primary brand will be used.**

Factory		<b>Stamford</b>
Model		<b>S1L2-Y1</b>
Single-phase Range	KVA	<b>62,5</b>
Voltage Regulator (voltage accuracy)	+/- %	<b>1</b>
Poles	N°	<b>4</b>
Phases	N°	<b>3+N</b>
Standard windings connection		<b>Star Series</b>
Stator/rotor impregnation		<b>H (Outdoor Temp 40°C)</b>
Efficiency	%	<b>90,1</b>
Engine coupling		<b>Elastic disk</b>
Short circuit current		<b>&gt;= 300% (3In)</b>
Protection degree	IP	<b>23</b>
Cooling system		<b>Self ventilating</b>
Maxium overspeed	rpm	<b>2250</b>
Waveform distortion	%	<b>&lt;5</b>
Exciter		<b>Diode bridge</b>

## Standard operating environmental conditions

Ambient temperature	°C	<b>25</b>
Relative Humidity	%	<b>30</b>



Max altitude

mt

**1000**

---

# Control Systems on board QPE-C-SC-3F-4P-160-O2

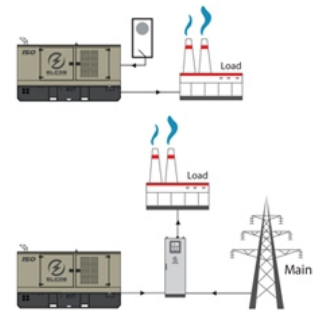

operating scheme - schema di funzionamento

## QPE Automatic panel without switching on board

The QPE-C control panel represents the evolution of the panel for the control and management of the gen set. With its microprocessor logic it is able to meet any user requested features. The dual operation mode manual and automatic guarantees to every type of functionality protection, analysis and control of the generating set in order to make the management easy and efficient. Variant without transfer switch on board. ATS panel type QC as optional. The panel manages the QC panels directly or any other ATS panel.

### Mechanical features

Protection degree	IP	55
-------------------	----	----

### Battery charger

Model		ELCOS - CB1
Maximum output current	A	2,5
Output DC voltage (selectable)	V <sub>dc</sub>	12-24
Input AC voltage (selectable)	V <sub>ac</sub>	220-260
Frequency	Hz	50-60

### Data Communication

Data connection port		RS-485
Communication protocol		Mod-bus RTU-8N1

### Remotable functions in terminal box

GS start	GS lock
Genset contactor close/open command (1)	Mains contactor close/open command (2)
Common Alarm - DC output	GS test without load
GS start with key in OFF position (Only in MRS mode)	Programmable output - Volt free output

(1) Ready to load function (MRS mode only)(2) AMF mode only

## Control Module



Model	<b>MC4</b>
Operating mode	<b>AMF - MRS</b>

### Specifics

#### Applications

Emergency to the Mains  
Stand-alone  
Construction site/Rental  
Self-production

#### ENGINE MEASURES

Fuel tank level %  
Engine oil pressure BAR (1)  
Engine Coolant temperature °C (1)  
Total run time  
Partial run time  
Hours to maintenance  
Battery voltage  
Battery charging voltage  
Start-ups counter  
Engine speed (2)  
Engine Oil temperature (2)  
Cooler temperature (2)  
Engine oil level (2)  
Engine coolant level (2)  
Engine coolant pressure (2)  
Turbo pressure (2)  
Fuel Consumption (2)  
Tank autonomy - hrs (5)  
Fuel remaining quantity (5)  
Fuel used quantity (5)

#### ALTERNATOR MEASURES

Generator Voltage L1, L2, L3  
Generator Voltage L1-N, L2-N, L3-N  
Generator frequency  
Generator current L1, L2, L3  
Generator Apparent Power kVA  
Generator Active Power kW  
Generator Reactive Power kVAR  
Generator accumulated power kWh  
Power factor Cosfi

#### MAINS MEASURES

Mains voltage L1, L2, L3  
Mains voltage L1-N, L2-N, L3-N  
Mains frequency

#### COMMUNICATION PORTS

Can-bus port  
RS485 port with Mod-bus RTU communication  
RS232 port for display connection  
USB port for parameters saving and firmware update

#### EQUIPMENT

Microprocessor Logic  
Back-lit display  
Programmable from display  
16 event log  
Multiple display languages  
STOP button  
START button  
TEST button  
Reset alarm button  
Alarm mute button  
Fuel transfer pump activation button  
Glow-plug activation button

#### PRE-ALARMS/ ALARMS

Common Alarm  
Fuel reserve (pre-alarm)  
Low fuel level (alarm)  
Tank overflow  
Charge alternator failed (dinamo)  
Low oil pressure (pre-alarm) (1)  
Low oil pressure (alarm)  
Oil sensor failed (alarm)  
High coolant temperature (pre-alarm) (1)  
High coolant temperature (alarm)  
Low coolant temperature (pre-alarm)  
Low water level (1)  
Water in fuel (1)  
Battery undervoltage  
Battery overvoltage  
GS failure to start  
GS failure to stop  
Can-bus Failure  
No Can-bus communication  
Genset overload L1, L2, L3 phases  
Genset short circuit  
Genset overvoltage  
Genset undervoltage  
Genset high frequency  
Genset low frequency  
overspeed  
Reverse power  
Earth fault (pre-alarm)  
Earth fault (alarm)  
Block from password  
CAN communication Failed  
Maintenance request  
Emergency button pressed  
Remote emergency active  
Forced stop  
External battery failed  
Fuel theft  
Genset negative phase sequence  
Mains negative phase sequence  
Fuel theft protection

#### VISUALIZATIONS ON CONTROL MODULE/DISPLAY

Pre-alarms  
Alarms  
Engine measures  
Alternator measures  
Mains measures  
Date and time  
Operating mode  
Genset status  
Mains status  
Mains contactor status  
Genset contactor status  
Digital Input and Output status  
Grounding current mA (3)  
Grounding current threshold mA (3)  
Delay time of differential protection (3)  
Glow plugs status

#### CONTROL MODULE FUNCTIONS

Automatic start and stop when the Mains Fails (7)  
Remote Start and Stop  
Remote Start and Stop with key in OFF position  
Manual Start and stop  
Emergency stop button on panel board  
Remote emergency stop  
Remote lock  
Remote test without load  
Remote test on load  
Scheduled start-ups  
MODBUS commands (Start, Stop, Reset, Test)

#### CONTROL MODULE SPECIAL FUNCTIONS (on demand)

Automatic charging of an external battery  
Dummy load (4)  
Load shedding (4)  
Redundant starter motor management  
Fuel monitoring  
GS battery Load test  
Idle mode  
Service phone number indication  
Variable speed Generator  
Master / Slave mode

- (1) Present with the sensor installed on engine
- (2) Present according to the engine equipment and to the ECU type (ECU - Canbus)
- (3) Present only with the residual current device mounted on genset board
- (4) Present with optional expansion modules
- (5) Present with special function activated
- (6) Only with the optional of the automatic fuel refilling system on board
- (7) Only in AMF mode

AAABBB

## OPTIONAL

### Fuel Supply

**O.G-ACO-AT-C3V-01**

External fuel tank connections with 3-way valve for supply from internal or external tank (10/100 kVA)

**O.G-ACO-AT-C3V-AR-01**

Quick coupling connectors with 3-way valve for internal or external fuel tank connection (10/100 kVA)

**O.G-ACO-AT-CI-01**

External tank connections for supply only from external tank (g without tank) GE 10/100

**O.G-ACO-BT-C2200-1000**

1000 Lt Oversized Fuel Tank on board for SS, RB (50/60 kVA)

**O.G-ACO-GA-01**

Mechanical analogue float for internal fuel tank on board

**O.G-ACO-GA-02**

Electrical analogue float to monitor the external refilling point on board

**O.G-ACO-RE-01**

External refilling point for Gen Sets 10/250 kVA, SS, RB versions

**O.G-ACO-RE-SP-01**

External refilling point with warning light for Gen Sets 10/250 kVA, SS, RB versions

**O.G-ACO-ST-BG-ES1**

"Easy" automatic fuel refilling system on board, controlled by QPE-C and QLE-B panels

**O.G-ACO-ST-BG-STD**

"Standard" automatic fuel refilling system on board, controlled by QPE-C and QLE-B panels

**O.G-ACO-TK-ST-250**

Partitioned metal tank and reinforced brackets for transport on trailer (SS only)

### Alternator

**O.G-ALT-AL-CHBR-02**

Different brand alternator 50/100 kVA (Check dimensions)

### Batteries

**O.G-BAT-BAE-02**

Maintenance free high efficiency starter batteries (50/100 kVA)











**O.G-BAT-DOB-01**

Redundant battery kit for Gen Sets 50/100 kVA



**O.G-BAT-STB-01**

Battery isolator lockable (10/100 kVA)

## ⚙️ Canopy

	<b>O.G-COF-AM-01</b>	Hinges and Doors with tamper-proof device (10/100 kVA)
	<b>O.G-COF-AP-01</b>	Door opening alarm system (each door)
	<b>O.G-COF-C2200-INOX</b>	Additional cost for stainless steel canopy (C2200)
	<b>O.G-COF-CA-C2200</b>	IP 43 Conveyors for Gen Sets 50/60 kVA - supplied disassembled
	<b>O.G-COF-CH-03</b>	Additional cost for larger canopy C2600 instead of standard C2200 - Dim. cm 260x110x168H - Fuel tank 250 lt
	<b>O.G-COF-DLO-C2200-15KW</b>	Dummy Load 15kW on board for GE 50/60 kVA
	<b>O.G-COF-EAF-03</b>	Frontal air expulsion for Gen Sets 50/100 kVA (C2200/C2600) (change the noise level)
	<b>O.G-COF-FP-01</b>	Door stop (10/100 kVA)
	<b>O.G-COF-IL-01</b>	Internal LED lighting with micro-switches for Gen Sets 10/250 kVA
	<b>O.G-COF-PV-01</b>	Lift off doors kit (10/100 kVA) for SS and PRO version
	<b>O.G-COF-TRT-MAR-02</b>	High resistance canopy treatment for corrosive environments for 50/100 kVA (SS, RB Versions)
	<b>O.G-COF-VER-PAR-02</b>	Canopy custom paint (Grey base-frame) for 50/100 kVA (SS, RB Versions)
	<b>O.G-COF-VER-TOT-02</b>	Total canopy custom paint for 50/100 kVA (SS, RB Versions)

## ⚙️ Electrical on board

	<b>O.G-USP-125A5P</b>	Output power socket 125A EC 5P (50/80 kVA) for Gen Sets SS Version +011
	<b>O.G-USP-MO-02</b>	Terminal box with tightening terminals inside the cable entry compartment for Gen Sets 50/100 kVA SS Version
	<b>O.G-USP-MPRB-02</b>	RB module with 5 sockets, 1 plug and power cable access for GE from 50 to 100 KVA SS version (check feasibility)

## ⚙️ Engine





**O.G-MOT-FC-3**

Dust collector filter - for Gen Sets 50/60 kVA



**O.G-MOT-FSA-3**

Fuel/Water Separator Filter - for Gen Sets 50/60 kVA



**O.G-MOT-K-40C-02**

Engine liquids suitable for -40°C ambient temperature for Gen Sets 50/100 kVA



**O.G-MOT-PO-01**

Oil change pump for Gen Sets 10/100 kVA



**O.G-MOT-RF-02**

Electronic speed governor for Gen Sets 50/200 kVA



**O.G-MOT-SC-AC-EL-01**

Engine pre-heater 230V with thermostat on board for Gen Sets 10/100 kVA + 130/500 PRO version



**O.G-MOT-SC-AC-EL-02**

Super hot engine heater 230V with thermostat on board for Gen Sets 10/100 kVA



**O.G-MOT-SE-LR-01**

Radiator coolant level sensor from 10 to 100 Kva



**O.G-MOT-SE-PO-LR**

Oil pressure level and engine temperature sensors (from 10 to 100kVA)



**O.G-MOT-SRO-AU-18L**

Automatic oil refilling system (50/100 kVA)

## ⚙ Handling



**O.G-MOV-CN-4**

Off-road trailer with 2 pneumatic wheels and tow bar (SS, RB Gen Sets 50/100 kVA)



**O.G-MOV-CO-ST-03**

Roadworthy trailer 80km/h (50/100 kVA), registration excluded.



**O.G-MOV-GC-BIG-01**

Increased central lifting hook with 10x5cm hole (10/250 kVA SS version)



**O.G-MOV-KRM-SS-02**

Reinforcement kit for mobile installation (dedicated trailers or wheeled machinery) SS Version from 50 to 100 kVA

## ⚙ Exhaust











**O.G-SCA-CAT-03**

Catalytic converter (25/60 kVA)



**O.G-SCA-FAP-K65**

Particulate filter (DPF) for Gen Sets 50/60 kVA

	<b>O.G-SCA-GF-80</b>	Exhaust bellow with flexible joint including flange and counter flange (50/250 kVA)
	<b>O.G-SCA-PF-02</b>	Spark arrester for Gen Sets 50/100 kVA
	<b>O.G-SCA-PR-03</b>	Exhaust pipe protection kit (50/100 kVA) , SS version
 <b>Test</b>		
	<b>MS.CP-LT-01</b>	FAT - Factory Acceptance Test for single Gen Set from 10 to 100 kVA according to our standard procedures in Elcos factory (max 2 hours - max 4 people - max 1 hour of operation)
	<b>MS.CP-SP-01</b>	FAT - Factory Acceptance Test for single custom Gen Set from 10 to 100 kVA max 4 operating hours or parallel system up to 4 units for 1 operating hour, in Elcos factory (max 4 hours - max 4 people )
	<b>MS.CP-ST-01</b>	FAT - Factory Acceptance Test for single Gen Set from 10 to 100 kVA according to our standard procedures in Elcos factory (max 4 hours - max 4 people - max 2 hour of operation)
	<b>MS.RF-ST-01</b>	Noise test report for single Gen Set from 10 to 250 kVA
	<b>MS.TV-ST-01</b>	Vibration test on 10 points with certificate for single Gen Set from 10 to 250 kVA

## PRP

Engines of this rating provide unlimited hours of usage in a variable load application. The average load factor should not exceed 70% of the engine's prime power rating with a maximum number of 500 operational hours at 100% prime power rating. An overload capability of 10% is available, however, is limited to a period of 1 in every 12 hours

## LTP

Limited-time running power is defined as the maximum power available, under the agreed operating conditions, for which the generating set is capable of delivering for up to 500h of operation per year with the maintenance intervals. The overload is not allowed.

Sheet:	C 2600	SUPER SILENT	Exhaust side:		Type:	STANDARD	Rev:	02	Last Update:	Giu 10, 2015	Page 1/2
--------	--------	--------------	---------------	--	-------	----------	------	----	--------------	--------------	----------

**OVERALL DIMENSIONS [mm]**

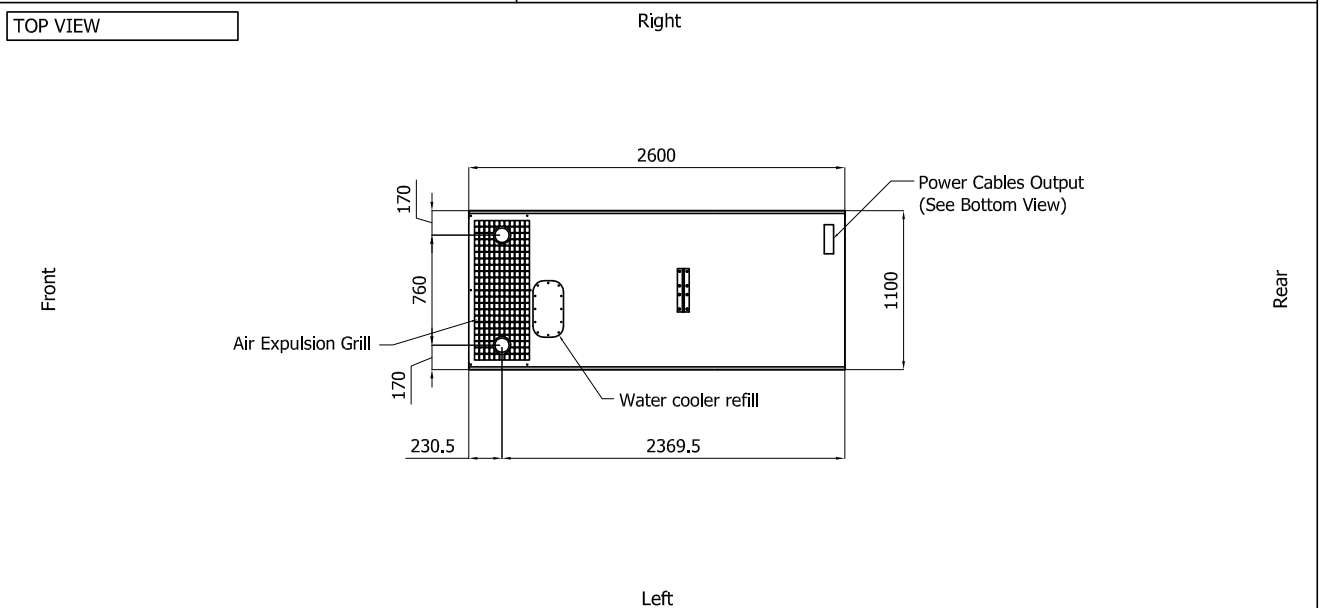
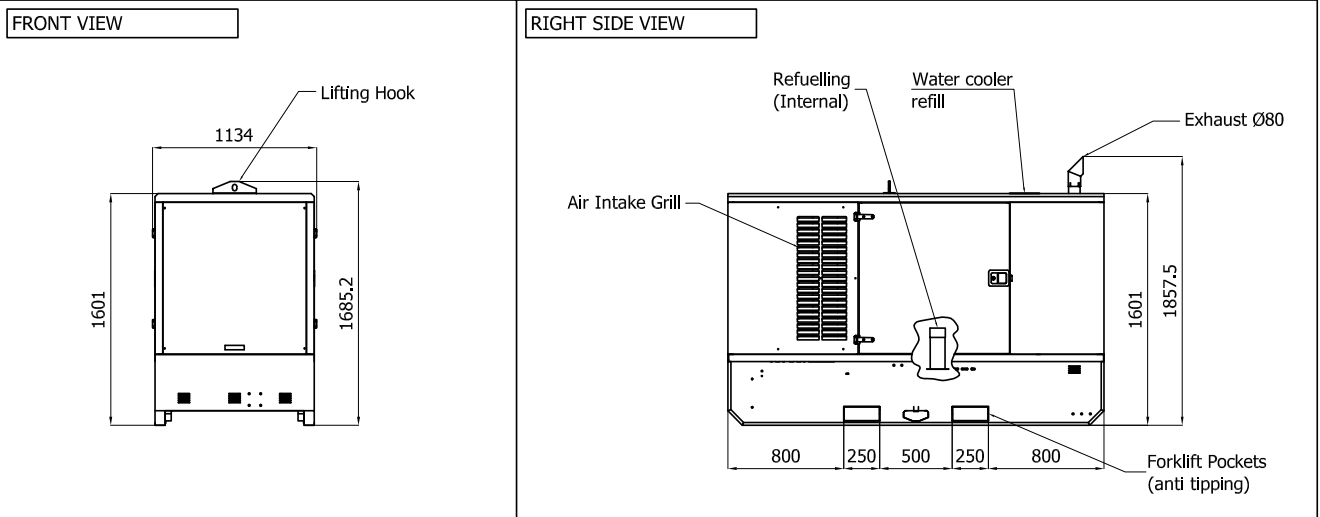
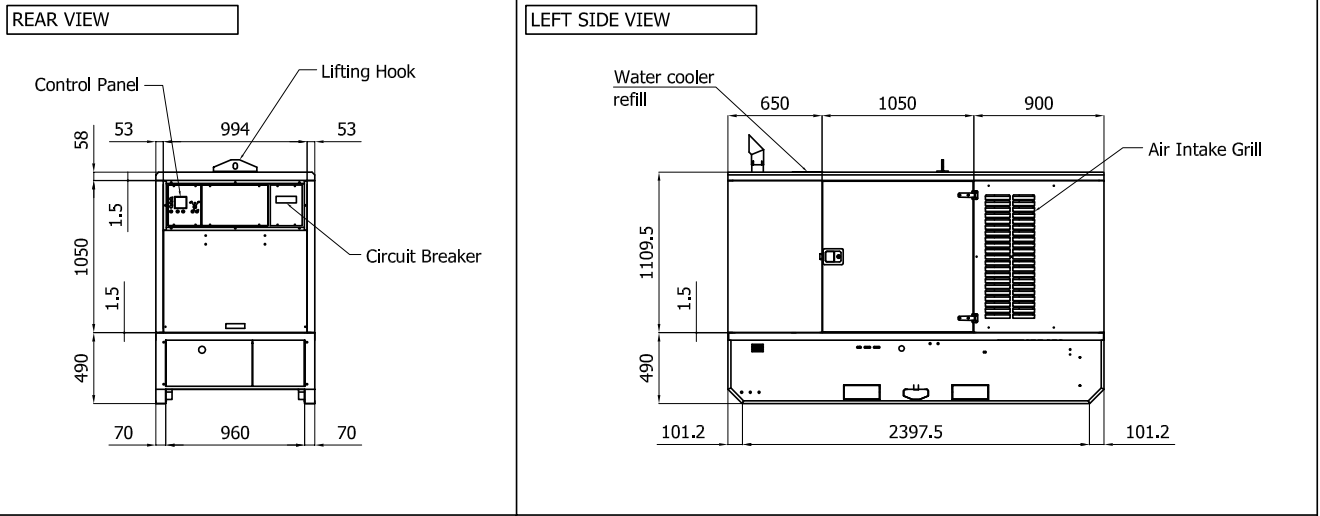

**IMPORTANT:**

- 1) Form and dimension refer to the generating set on catalogue
- 2) Form and dimension are subject to change in order to update or improve the products
- 3) This document can not be copied or transmitted without ELCOS S.r.l. approval

Sheet:	C 2600	SUPER SILENT	Exhaust side:		Type:	STANDARD	Rev:	02	Last Update:	Giu 10, 2015	Page 2/2
--------	--------	--------------	---------------	--	-------	----------	------	----	--------------	--------------	----------

**BOTTOM VIEW**

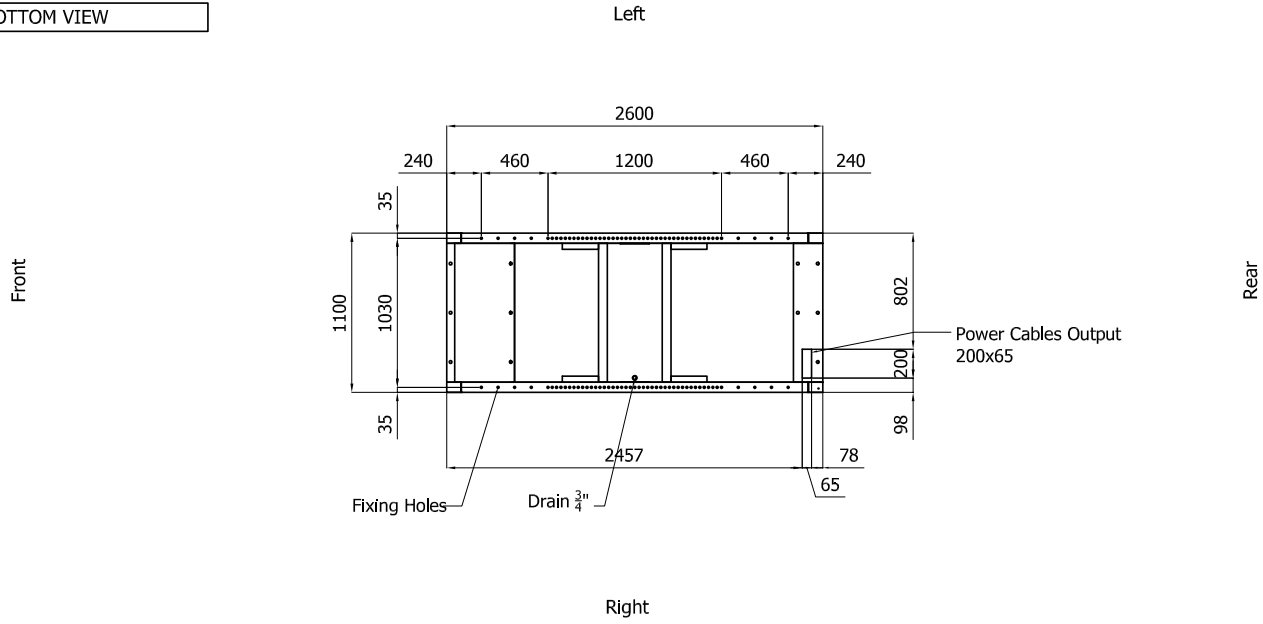

**DIMENSIONS WITH OPEN DOORS [mm]**

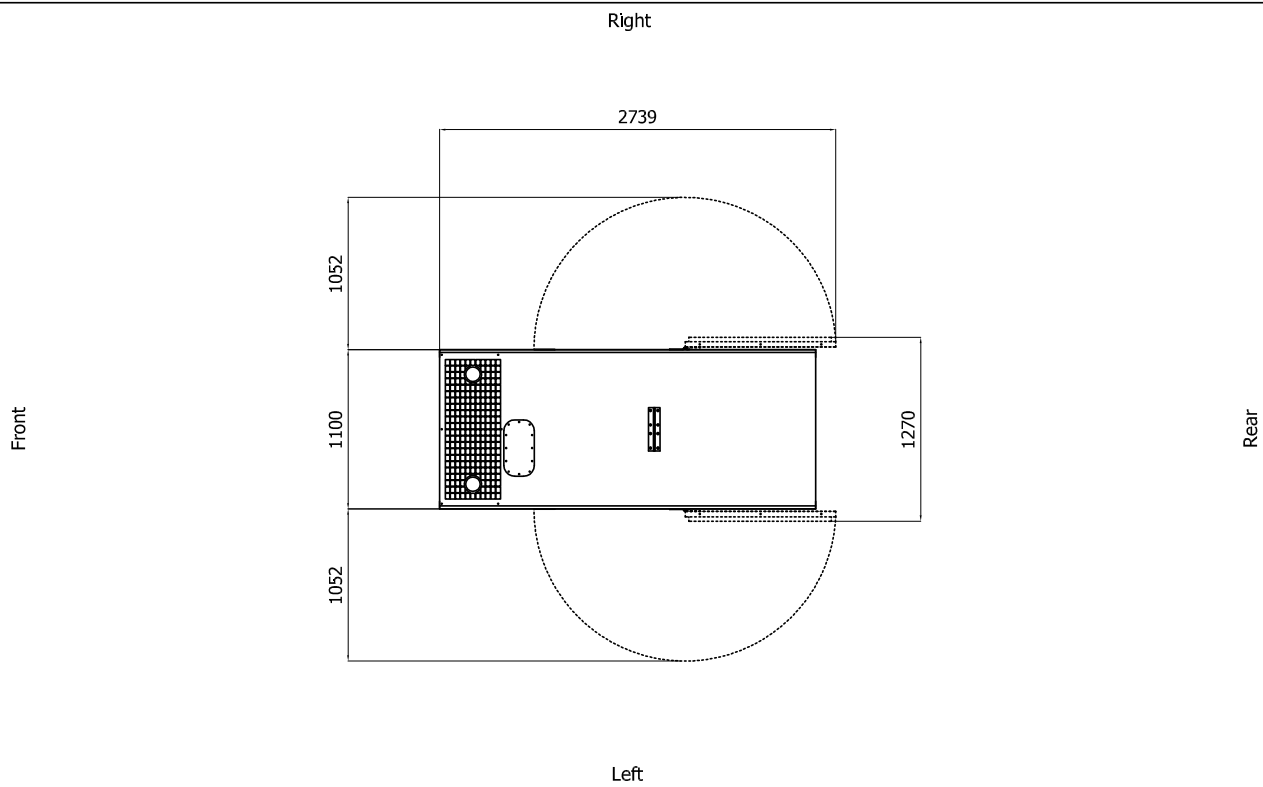

Note: With Lifting-Off Door Solution consider only canopy dimensions.  
(Models with "Control Panel" behind rear door will mount a special cover to protect it)

**VENTILATION OF THE ROOM**

The windows area in the generating set room needs to be (recommended):  
Aspiration: 1.00 m<sup>2</sup>  
Expulsion: 0.60 m<sup>2</sup>  
ATTENTION: for a correct ventilation the expulsion air and the exhaust gas needs to be conveyed in the open-air

- IMPORTANT:**
- 1) Form and dimension refer to the generating set on catalogue
  - 2) Form and dimension are subject to change in order to update or improve the products
  - 3) This document can not be copied or transmitted without ELCOS S.r.l. approval