



Image for demonstration purposes

  
**Generating Set**  
**Base Frame - Diesel**

## GE.BD.220/200.BF+011

1500 rpm - Threephase - 50Hz - 400V  
 Automatic panel without switching on board



## Standard equipment

### Exhaust

Exhaust manifold protection  
 Silenced muffler -15dB(A)

### Fuel Supply

Single wall daily tank with bunded base  
 Automatic shutdown system for low fuel level  
 Fuel gauge

### Handling

Loadable side by side for truck transportation

### Base Frame

Anti-vibrating mounting pads  
 Anti pollution Bunded base

### Engine

High coolant temperature and low oil pressure shutdown system  
 Oil pressure and coolant temperature gauge (only with QPE or +14 variant)  
 External oil drain points  
 Engine liquids (oil and antifreeze)  
 Tropicalized radiator  
 Rotating parts protection  
 Electronic speed governor

### Alternator

AVR Automatic Voltage Regulator  
 Impregnation for marine environment  
 IP23

### Panel & connection

Emergency Stop button  
 Non-Automatic circuit breaker on panel board  
 Cable output from the bottom  
 IP44 wiring  
 Start-up battery (pre-charged)  
 Grounding point

### Documentation

CE conformity declaration  
 User and Maintenance manual  
 Wirings diagrams

### Normatives

All Generating sets are compliant to CE Marking  
 2014/30/UE Electromagnetic compatibility  
 2000/14/CE Noise Emission for outdoor use  
 Factory-designed systems built according to ISO 9001:2015  
 CEI EN 60204-1:2018 - Electrical equipment of machines

## Primary data

### General Information

Speed	RPM	1500
Frequency	Hz	50
PRP	KVA	200
PRP - Prime power	KW	160,0
LTP - Standby power	KVA	220
LTP - Standby power	KW	176,0
Standard Voltage	V	400/230
Current	A	289,02
Voltage for current calculation	V	400
COSFI	0,8	0,8

### General electrical protection

Circuit-breaker rated current	A	320
Type	Non-Automatic circuit breaker on panel board	
Circuit-breaker poles	N	4P
Optional/notes circuit-breaker	Opening coil	

### Fuel Consumption

TYPE		Diesel
Standard Fuel Tank capacity	lt	250
Autonomy @ 75% load	h	8
Fuel consumption at 100% load	lt/h	42,1
Fuel consumption at 75% load	lt/h	31,6
Fuel consumption at 50% load	lt/h	21,9

### General data

Rated capacity	Ah	2x120
Auxiliary Voltage	V	24
Exhaust gas temperature	°C	600
Exhaust gas flow	l/s	618
Combustion air flow	l/s	230
Cooling fan airflow	mc/s	6,9
Exhaust diameter	mm	80

### Weight and Dimensions

Dimensions (L x w x h)	cm	285x118x185
Weight with liquids (excluding optionals and fuel)	Kg (+/-3%)	2115

## ⚙️ Engine

Factory		<b>Baudouin</b>
Model		<b>6M16G220/5</b>
Emissions stage		<b>Stage 0</b>
Speed governor		<b>Electronic</b>
Radiator	°C	<b>50</b>
Cooling	Tipo	<b>liquid (water + 50% Paraflu11)</b>
Active net power	Kwm	<b>174,4</b>
Nominal net power	CV	<b>237</b>
Cycle	Tipo	<b>4 strokes</b>
Aspiration	Tipo	<b>Turbo</b>
Numbers of cylinders	N	<b>6</b>
Cylinders arrangement		<b>L</b>
Bore	mm	<b>126</b>
Stroke	mm	<b>130</b>
Total displacement	lt	<b>9,721</b>
Engine oil features		<b>15W40-API CI-4/CH-4 ACEA E5-E7</b>
Total oil capacity	lt	<b>30</b>
Total coolant capacity	lt	<b>44</b>
ISO 8528-5 class		<b>G2</b>

## ⚙️ Alternator

\* May vary based on stock availability. However, a primary brand will be used.

Factory		<b>Stamford</b>
Model		<b>UCI274H</b>
Single-phase Range	KVA	<b>200</b>
Voltage Regulator (voltage accuracy)	+/- %	<b>1</b>
Poles	N°	<b>4</b>
Phases	N°	<b>3+N</b>
Standard windings connection		<b>Star Series</b>
Stator/rotor impregnation		<b>H (Outdoor Temp 40°C)</b>
Efficiency	%	<b>93,3</b>
Engine coupling		<b>Elastic disk</b>
Short circuit current		<b>&gt;= 300% (3In)</b>
Protection degree	IP	<b>23</b>
Cooling system		<b>Self ventilating</b>
Maxium overspeed	rpm	<b>2250</b>
Waveform distortion	%	<b>&lt;5</b>
Exciter		<b>Diode bridge</b>

## ⚙️ Standard operating environmental conditions

Ambient temperature	°C	<b>25</b>
Relative Humidity	%	<b>30</b>
Max altitude	mt	<b>1000</b>

# Control Systems on board QPE-C-SC-3F-4P-400-O3

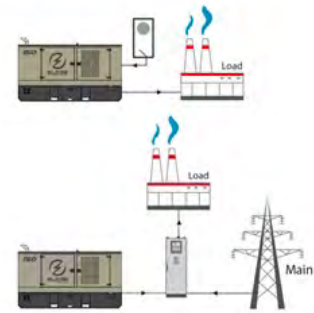

operating scheme - schema di funzionamento

## QPE Automatic panel without switching on board

The QPE-C control panel represents the evolution of the panel for the control and management of the gen set. With its microprocessor logic it is able to meet any user requested features. The dual operation mode manual and automatic guarantees to every type of functionality protection, analysis and control of the generating set in order to make the management easy and efficient. Variant without transfer switch on board. ATS panel type QC as optional. The panel manages the QC panels directly or any other ATS panel.

### Mechanical features

Protection degree	IP	55
-------------------	----	----

### Battery charger

Model		ELCOS - CB1
Maximum output current	A	2,5
Output DC voltage (selectable)	V <sub>dc</sub>	12-24
Input AC voltage (selectable)	V <sub>ac</sub>	220-260
Frequency	Hz	50-60

### Data Communication

Data connection port		RS-485
Communication protocol		Mod-bus RTU-8N1

### Remotable functions in terminal box

GS start	GS lock
Genset contactor close/open command (1)	Mains contactor close/open command (2)
Common Alarm - DC output	GS test without load
GS start with key in OFF position (Only in MRS mode)	Programmable output - Volt free output

(1) Ready to load function (MRS mode only)(2) AMF mode only

## Control Module



Model	MC4
Operating mode	AMF - MRS

### Specifics

#### Applications

Emergency to the Mains  
Stand-alone  
Construction site/Rental  
Self-production

#### ENGINE MEASURES

Fuel tank level %  
Engine oil pressure BAR (1)  
Engine Coolant temperature °C (1)  
Total run time  
Partial run time  
Hours to maintenance  
Battery voltage  
Battery charging voltage  
Start-ups counter  
Engine speed (2)  
Engine Oil temperature (2)  
Cooler temperature (2)  
Engine oil level (2)  
Engine coolant level (2)  
Engine coolant pressure (2)  
Turbo pressure (2)  
Fuel Consumption (2)  
Tank autonomy - hrs (5)  
Fuel remaining quantity (5)  
Fuel used quantity (5)

#### ALTERNATOR MEASURES

Generator Voltage L1, L2, L3  
Generator Voltage L1-N, L2-N, L3-N  
Generator frequency  
Generator current L1, L2, L3  
Generator Apparent Power kVA  
Generator Active Power kW  
Generator Reactive Power kVAR  
Generator accumulated power kWh  
Power factor Cosfi

#### MAINS MEASURES

Mains voltage L1, L2, L3  
Mains voltage L1-N, L2-N, L3-N  
Mains frequency

#### COMMUNICATION PORTS

Can-bus port  
RS485 port with Mod-bus RTU communication  
RS232 port for display connection  
USB port for parameters saving and firmware update

#### EQUIPMENT

Microprocessor Logic  
Back-lit display  
Programmable from display  
16 event log  
Multiple display languages  
STOP button  
START button  
TEST button  
Reset alarm button  
Alarm mute button  
Fuel transfer pump activation button  
Glow-plug activation button

#### PRE-ALARMS/ ALARMS

Common Alarm  
Fuel reserve (pre-alarm)  
Low fuel level (alarm)  
Tank overflow  
Charge alternator failed (dinamo)  
Low oil pressure (pre-alarm) (1)  
Low oil pressure (alarm)  
Oil sensor failed (alarm)  
High coolant temperature (pre-alarm) (1)  
High coolant temperature (alarm)  
Low coolant temperature (pre-alarm)  
Low water level (1)  
Water in fuel (1)  
Battery undervoltage  
Battery overvoltage  
GS failure to start  
GS failure to stop  
Can-bus Failure  
No Can-bus communication  
Genset overload L1, L2, L3 phases  
Genset short circuit  
Genset overvoltage  
Genset undervoltage  
Genset high frequency  
Genset low frequency  
overspeed  
Reverse power  
Earth fault (pre-alarm)  
Earth fault (alarm)  
Block from password  
CAN communication Failed  
Maintenance request  
Emergency button pressed  
Remote emergency active  
Forced stop  
External battery failed  
Fuel theft  
Genset negative phase sequence  
Mains negative phase sequence  
Fuel theft protection

#### VISUALIZATIONS ON CONTROL

##### MODULE/DISPLAY

Pre-alarms  
Alarms  
Engine measures  
Alternator measures  
Mains measures  
Date and time  
Operating mode  
Genset status  
Mains status  
Mains contactor status  
Genset contactor status  
Digital Input and Output status  
Grounding current mA (3)  
Grounding current threshold mA (3)  
Delay time of differential protection (3)  
Glow plugs status

##### CONTROL MODULE FUNCTIONS

Automatic start and stop when the Mains Fails (7)  
Remote Start and Stop  
Remote Start and Stop with key in OFF position  
Manual Start and stop  
Emergency stop button on panel board  
Remote emergency stop  
Remote lock  
Remote test without load  
Remote test on load  
Scheduled start-ups  
MODBUS commands (Start, Stop, Reset, Test)

##### CONTROL MODULE SPECIAL FUNCTIONS (on demand)

Automatic charging of an external battery  
Dummy load (4)  
Load shedding (4)  
Redundant starter motor management  
Fuel monitoring  
GS battery Load test  
Idle mode  
Service phone number indication  
Variable speed Generator  
Master / Slave mode

- (1) Present with the sensor installed on engine
- (2) Present according to the engine equipment and to the ECU type (ECU - Canbus)
- (3) Present only with the residual current device mounted on genset board
- (4) Present with optional expansion modules
- (5) Present with special function activated
- (6) Only with the optional of the automatic fuel refilling system on board
- (7) Only in AMF mode

AAABBB

## OPTIONAL

### Fuel Supply

**O.G-ACO-AT-C3V-02**

External fuel tank connections with 3-way valve for supply from internal or external tank (130/700 kVA)

**O.G-ACO-AT-CI-02**

External tank connections for supply only from external tank (g without tank) GE 130/700

**O.G-ACO-BT-P3700-1000**

1000 Lt Oversized Fuel Tank on board for BF/PRO (180/250 kVA) (Increased weight and size)

**O.G-ACO-BT-P3700-600**

600 Lt Oversized Fuel Tank on board for BF/PRO (180/250 kVA), (Increased weight and size)

**O.G-ACO-GA-01**

Mechanical analogue float for internal fuel tank on board

**O.G-ACO-SP-01**

Tank leak sensor with signal reported in the QPE control panel

**O.G-ACO-ST-2P**

Double redundant electric pump kit for automatic fuel refilling system

**O.G-ACO-ST-BG-ES1**

"Easy" automatic fuel refilling system on board, controlled by QPE-C and QLE-B panels

**O.G-ACO-ST-BG-HDT**

"Heavy Duty" automatic fuel refilling system on board, controlled by QPE-C and QLE-B panels

**O.G-ACO-ST-BG-STD**

"Standard" automatic fuel refilling system on board, controlled by QPE-C and QLE-B panels

### Alternator

**O.G-ALT-AL-CHBR-03**

Different brand alternator 130/250 kVA (Check dimensions)

**O.G-ALT-AL-COTE-01**

Temperature control unit up to 4 x PT100 probes for MC4 management

**O.G-ALT-ST-ACO-01**

Anti-condensation heater 230 V (on Stamford from 80 to 2000 kVA)

**O.G-ALT-ST-AVR-MX321**

Stamford MX321 automatic voltage regulator with PMG (Check dimensions)

**O.G-ALT-ST-AVR-MX341**

Stamford MX341 automatic voltage regulator with PMG (Check dimensions)

**O.G-ALT-ST-PT100-1CU**

1 x PT100 probe on bearing (80/3000 kVA)

**O.G-ALT-ST-PT100-3AV**

nr. 3 RTD-PT100 probes on stator windings (80/3000 kVA)

**O.G-ALT-ST-PT100-6AV**

nr. 3+3 RTD-PT100 probes on stator windings (80/3000 kVA)

**O.G-ALT-ST-RIGU-01**

Diode Failure Detector (DFD) mounted on the alternator. Alarm contact available into the panel

 **Batteries**

**O.G-BAT-BAE-03**

Maintenance free high efficiency starter batteries (130/250 kVA)

**O.G-BAT-DOB-02**

Redundant battery kit for Gen Sets 130/250 kVA

**O.G-BAT-STB-02**

Battery isolator lockable(130/700 kVA)

 **Canopy**

**O.G-COF-55-COF-03**

55 dBA Canopy for Gen Sets 130/250 kVA (BF Version)

 **Electrical on board**

**O.G-USP-SW-MOT.0130-0250**

Motorization switch on board machine, integrated in the panel for 130/250 Kva Ge - (for variant +11)

**O.Q-QBM-BMIN-230V-02**

Additional price for 230V minimum voltage coil on MCCB both on the control panel and on the alternator (check feasibility)

**O.Q-QBM-CPI-BEN-01**

Permanent insulation controller for IT networks up to 230V / 400V. BENDER IR423-D4-1. Adjustable threshold 10 ÷ 300 kohm. (2 DIN rail modules - check feasibility)

**O.Q-QLE-K-DIF-M3**

Adjustable differential protection only for MC2-PLUS controller for Gen Sets 10/500 kVA (+011 variant)

**O.Q-QPE-485.CONV-LAN**

Converter 485/LAN for QPE-C, QLE-B panel

**O.Q-QPE-485.CONV-USB**

Converter 485/USB for QPE panel

**O.Q-QPE-DIS-MS.01**

MASTER/SLAVE device for QPE panel

**O.Q-QPE-INT-CST-03**

STATUS contact GE main switch wired to terminal board inside the QPE panel (130 / 250KVA) on board the GENERATOR.

**O.Q-QPE-K-DIF**

















Differential protection adjustable for the MC4

**O.Q-QPE-MD-QPE-C**

GSM remote management modem for QPE panel

**O.Q-QPE-POT-VOLT**

Internal potentiometer for voltage regulation - available only for variant +10/+11

	<b>O.Q-QPE-PR-QPE-C</b>	Remote panel for QPE-C, QLE-B - available only for variant +10/+11
	<b>O.Q-QPE-QBM-COM-AMF25</b>	Option with QBM COMAP AMF25 controller on board instead of QPE
	<b>O.Q-QPE-QBM-DSE-7320</b>	Option with QBM DSE7320 controller on board instead of QPE.
	<b>O.Q-QPE-RIL-16RELE</b>	16-relay module for QPE panel
	<b>O.Q-QPE-RX8-QPE-C</b>	Start-stop radio control with max. radius 500 mt indoors and 5 km outdoors (for QPE panel).
	<b>O.Q-QPE-SAS-02</b>	Auto Start-Stop at load request (QPE, QLE panels)
	<b>O.Q-QPE-SCD-01</b>	Anti-condensation heater inside the panel
	<b>O.Q-QPE-SEL-50-60</b>	Switch selector 50Hz 400V / 60Hz 480V
	<b>O.Q-QPE-TG-EVO-GPS-2G</b>	Remote management system via LAN/GSM 2G with WEB application and GPS location system
	<b>O.Q-QPE-TG-EVO-GPS-3G</b>	Remote management system via LAN/GSM 3G with WEB application and GPS location system
	<b>O.Q-QPE-TG-QPE-C</b>	Remote management software via LAN for QPE-C, QLE-B panel compatible with Windows XP and 7
<b>Engine</b>		
	<b>O.G-MOT-FC-6</b>	Dust collector filter - for Gen Sets 180/250 kVA
	<b>O.G-MOT-FSA-6</b>	Fuel/Water Separator Filter - for Gen Sets 180/250 kVA
	<b>O.G-MOT-K-40C-03</b>	Engine liquids suitable for -40°C ambient temperature for Gen Sets 130/250 kVA
	<b>O.G-MOT-MAG-02</b>	Dual starter motor for Gen Sets 180/250 kVA (engine configuration to be checked)
	<b>O.G-MOT-PO-02</b>	Oil change pump for Gen Sets 130/700 kVA



**O.G-MOT-RF-02**

Electronic speed governor for Gen Sets 50/200 kVA

**O.G-MOT-SC-AC-EL-03**

Super hot engine heater 230V with thermostat on board for Gen Sets 130/250 kVA

**O.G-MOT-SC-AC-WE-02**

Webasto diesel-operated water pre-heater (130/400 kVA)

**O.G-MOT-SE-LR-02**

Radiator coolant level sensor from 130 to 700 kVA

**O.G-MOT-SRO-AU-30L**

Automatic oil refilling system (130/250 kVA)

 **Handling**

**O.G-MOV-GC-BF-2700**

Central Lifting hook (180/250 kVA) BF Version

 **ATS Panels**

**QC2.0400A**

Separate ATS panel, ABB 400A motorized change-over (275 kVA 400V - 160 kVA 230V) Dim. 60 x 50 x 160 cm - 109 kg. (ex QC2.275)

**QCP2.0400A**

Separate ATS switching panel, with Lovato ATL 610 control unit, for variant +014, ABB motorized change-over 400A 4P (275kva 400V) and compartment for power cables inlet

**QLTS.400A**

Wall-mounted ATS switching panel 400A 4P (275 kVA 400V) Dim. 80 x 28 x 60 cm - 40 kg.

 **Exhaust**

**O.G-SCA-CAT-05**

Catalytic converter (130/250 kVA)

**O.G-SCA-FAP-K200**

Particulate filter (DPF) for Gen Sets 180/200 kVA

**O.G-SCA-GF-80**

Exhaust bellow with flexible joint including flange and counter flange (50/250 kVA)

**O.G-SCA-MR-05**

Residential muffler -35 dBA (130/250 kVA)

**O.G-SCA-MR-MO-02**

Installation on board for residential muffler, particulate filter, catalytic converter on BF (130/400 kVA)

**O.G-SCA-PF-03**

Spark arrestor for Gen Sets 130/250 kVA

 **Test**

**MS.CP-LT-02**

FAT - Factory Acceptance Test for single Gen Set from 130 to 400 kVA according to our standard procedures in Elcos factory (max 2 hours - max 4 people - max 1 hour of operation)

**MS.CP-SP-02**

FAT - Factory Acceptance Test for single custom Gen Set from 130 to 400 kVA max 4 operating hours or parallel system up to 4 units for 1 operating hour, in Elcos factory (max 4 hours - max 4 people )

**MS.CP-ST-02**

FAT - Factory Acceptance Test for single Gen Set from 130 to 400 kVA according to our standard procedures in Elcos factory (max 4 hours - max 4 people - max 2 hour of operation)

**MS.TV-ST-01**

Vibration test on 10 points with certificate for single Gen Set from 10 to 250 kVA

 **Vari**

**O.G-VAR-CAT-02**

Toolbox for ordinary maintenance.

**O.G-VAR-PUN-TER-01**

Round earth spike, diam. 20 mm, height 1.5mt, galvanized, complete with clamp and 3m yellow/green cable model FS17 1x35mm<sup>2</sup> with cable lugs.

**O.G-VAR-PUN-TER-02**

Cross-shaped earth spike, height 1.5mt, galvanized, complete with clamp and 3m yellow/green cable model FS17 1x35mm<sup>2</sup> with cable lugs.

**O.G-VAR-SFA-04**

Aspiration / expulsion sound attenuators -25dBA for Gen Sets 130/250 kVA BF Version

## PRP

Engines of this rating provide unlimited hours of usage in a variable load application. The average load factor should not exceed 70% of the engine's prime power rating with a maximum number of 500 operational hours at 100% prime power rating. An overload capability of 10% is available, however, is limited to a period of 1 in every 12 hours

## LTP

Limited-time running power is defined as the maximum power available, under the agreed operating conditions, for which the generating set is capable of delivering for up to 500h of operation per year with the maintenance intervals. The overload is not allowed.

Sheet:	GE.BD.220.200.BF	OPEN FRAME	Exhaust side:	-	Type:	STANDARD	Rev:	00	Last Update:	25-09-2020	Page 1/2
--------	------------------	------------	---------------	---	-------	----------	------	----	--------------	------------	----------

**OVERALL DIMENSIONS [mm]**

<p><b>REAR VIEW</b></p> <p>Control Panel</p> <p>1845 1659 1179</p>	<p><b>LEFT SIDE VIEW</b> GE.BD.220\200.BF</p> <p>MUFFLER</p> <p>Ø80 760 Ø80 (int) Ø200 540 1845 2230 2850</p>
--	---

<p><b>FRONT VIEW</b> GE.BD.220\200.BF</p> <p>Air Expulsion</p> <p>1845 1183 840 705 134 901 144 1179</p>	<p><b>RIGHT SIDE VIEW</b> GE.BD.220\200.BF</p> <p>1845 1305 540 382 2468 2850 90 450 Refuelling</p>
--	---

**TOP VIEW**

1179  
263  
963  
2850  
Refuelling  
Power Cables Output (See Bottom View)  
Control Panel  
Exhaust - Ø80  
Front  
Rear  
Left  
Right

**IMPORTANT:**

- 1) Form and dimension refer to the generating set on catalogue
- 2) Form and dimension are subject to change in order to update or improve the products
- 3) This document can not be copied or transmitted without ELCOS S.r.l. approval

Sheet:	GE.BD.220.200.BF	OPEN FRAME	Exhaust side:		Type:	STANDARD	Rev:	00	Last Update:	25-09-2020	Page 2/2
--------	------------------	------------	---------------	--	-------	----------	------	----	--------------	------------	----------

**BOTTOM VIEW**

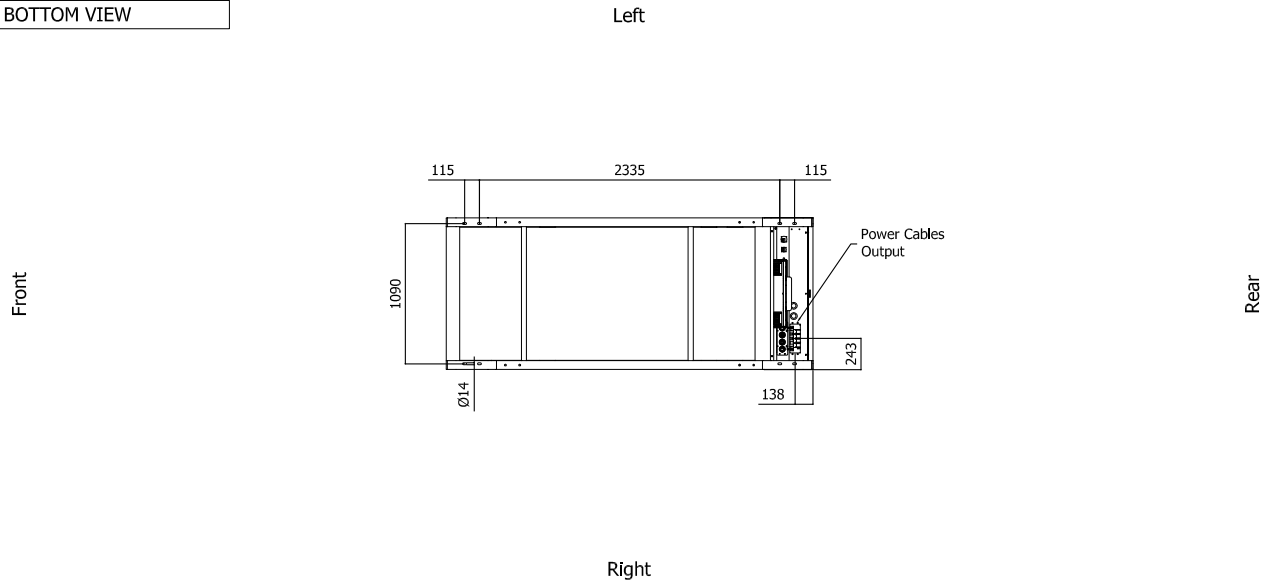

**3D VIEW**

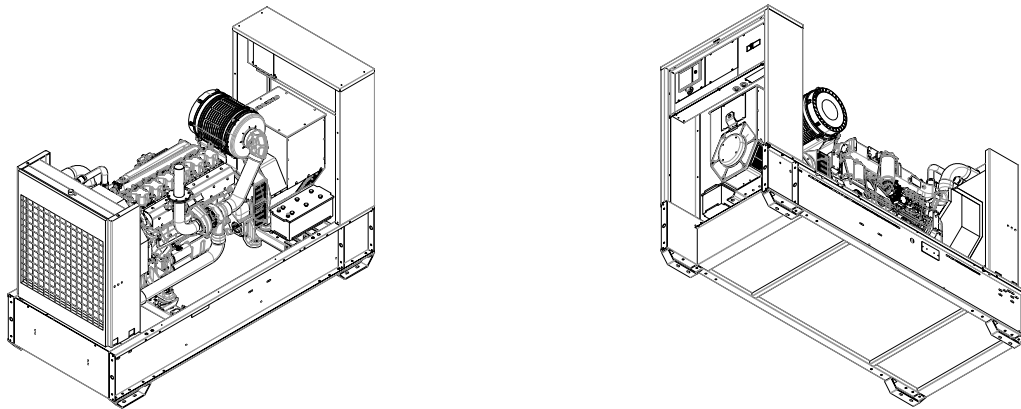

**VENTILATION OF THE ROOM**

The windows area in the generating set room needs to be (recommended):

Aspiration: 1.08 m<sup>2</sup>

Expulsion: 0.86 m<sup>2</sup>

ATTENTION: for a correct ventilation the expulsion air and the exhaust gas needs to be conveyed in the open-air

**IMPORTANT:**

- 1) Form and dimension refer to the generating set on catalogue
- 2) Form and dimension are subject to change in order to update or improve the products
- 3) This document can not be copied or transmitted without ELCOS S.r.l. approval