



Image for demonstration purposes

 **Generating Set**  
**SUPERSILENT - Diesel**

## GE.AI3A.440/400.SS+011

1500 rpm - Threephase - 50Hz - 400V  
Automatic panel without switching on board



## Standard equipment

### **Canopy Soundproofing**

Soundproofing with class 1 polyester material  
Handles with key lock and automatic closing  
Special baffles for air intake and air expulsion  
Inspection doors for controls and maintenance

### **Exhaust**

Exhaust rain cap  
Exhaust manifold protection  
Insulated exhaust pipes  
Internal residential muffler - 35dB(A)

### **Fuel Supply**

Single wall daily tank with bunded base  
Automatic shutdown system for low fuel level  
Fuel gauge

### **Handling**

Lifting hook integrated into the bearing structure  
Base frame with anti-overturning forklift pockets

### **Base Frame**

Bunded base at 110% of fuel tank capacity  
Anti-vibrating mounting pads  
Battery compartment externally accessible for easy service

### **Engine**

Engine pre-heater 230V  
High coolant temperature and low oil pressure shutdown system  
Oil pressure and coolant temperature gauge (only with QPE or +14 variant)  
External oil drain points  
Engine liquids (oil and antifreeze)  
Tropicalized radiator  
Rotating parts protection  
Electronic speed governor

### **Alternator**

AVR Automatic Voltage Regulator  
AVR Pre-arranged for parallel  
Impregnation for marine environment  
IP23

### **Panel & connection**

Emergency Stop button  
Magnetothermal circuit breaker on alternator board  
Tamperproof panel IP55  
Cable output from side  
IP44 wiring  
Start-up battery (pre-charged)  
Grounding point

### **Documentation**

CE conformity declaration  
User and Maintenance manual  
Wirings diagrams

### **Normatives**

All Generating sets are compliant to CE Marking  
2014/30/UE Electromagnetic compatibility  
2000/14/CE Noise Emission for outdoor use  
Factory-designed systems built according to ISO 9001:2015  
CEI EN 60204-1:2018 - Electrical equipment of machines

## Primary data

### General Information

Speed	RPM	1500
Frequency	Hz	50
PRP	KVA	400
PRP - Prime power	KW	320,0
LTP - Standby power	KVA	440
LTP - Standby power	KW	352,0
Standard Voltage	V	400/230
Current	A	578,03
Voltage for current calculation	V	400
COSFI	0,8	0,8

### General electrical protection

Circuit-breaker rated current	A	630
Type	Magnetothermal switch on the alternator board	
Circuit-breaker poles	N	4P

### Noise level +/- 3dB(A)

LWA	dB(A)	94
Sound pressure level @ 7 mt	dB(A)	69
Sound pressure level @ 1 mt	dB(A)	78

### Fuel Consumption

TYPE		Diesel
Standard Fuel Tank capacity	lt	600
Autonomy @ 75% load	h	8
Fuel consumption at 100% load	lt/h	92,9
Fuel consumption at 75% load	lt/h	81
Fuel consumption at 50% load	lt/h	53

### General data

Rated capacity	Ah	2x180
Auxiliary Voltage	V	24
Exhaust diameter	mm	140
Exhaust side		DX

### Weight and Dimensions

Dimensions (L x w x h)	cm	410x150x230
Weight with liquids (excluding optionals and fuel)	Kg (+/-3%)	3995

## ⚙️ Engine

Factory		<b>FPT</b>
Model		<b>C13TE2F</b>
Emissions stage		<b>Stage 3A</b>
Speed governor		<b>Electronic</b>
Radiator	°C	<b>50</b>
Cooling	Tipo	<b>liquid (water + 50% Paraflu11)</b>
Active net power	Kwm	<b>342</b>
Nominal net power	CV	<b>464,7</b>
Cycle	Tipo	<b>4 strokes</b>
Injection	Tipo	<b>Direct</b>
Aspiration	Tipo	<b>Turbo</b>
Numbers of cylinders	N	<b>6</b>
Cylinders arrangement		<b>L</b>
Bore	mm	<b>135</b>
Stroke	mm	<b>150</b>
Total displacement	lt	<b>12,876</b>
Engine oil features		<b>15W40-API CI-4/CH-4 ACEA E5-E7</b>
Total oil capacity	lt	<b>35</b>
Total coolant capacity	lt	<b>67</b>
ISO 8528-5 class		<b>G3</b>

## ⚙️ Alternator

**\* May vary based on stock availability. However, a primary brand will be used.**

Factory		<b>Stamford</b>
Model		<b>S4L1D-F</b>
Single-phase Range	KVA	<b>415</b>
Voltage Regulator (voltage accuracy)	+/- %	<b>1</b>
Poles	N°	<b>4</b>
Phases	N°	<b>3+N</b>
Standard windings connection		<b>Star Series</b>
Stator/rotor impregnation		<b>H (Outdoor Temp 40°C)</b>
Efficiency	%	<b>93,2</b>
Engine coupling		<b>Elastic disk</b>
Short circuit current		<b>&gt;= 300% (3In)</b>
Protection degree	IP	<b>23</b>
Cooling system		<b>Self ventilating</b>
Maxium overspeed	rpm	<b>2250</b>
Waveform distortion	%	<b>&lt;5</b>
Exciter		<b>Diode bridge</b>

## ⚙️ Standard operating environmental conditions

Ambient temperature	°C	<b>25</b>
Relative Humidity	%	<b>30</b>
Max altitude	mt	<b>1000</b>

# Control Systems on board QPE-C-SC-3F-V1



operating scheme - schema di funzionamento

## QPE Automatic panel without switching on board

The QPE-C control panel represents the evolution of the panel for the control and management of the gen set. With its microprocessor logic it is able to meet any user requested features. The dual operation mode manual and automatic guarantees to every type of functionality protection, analysis and control of the generating set in order to make the management easy and efficient. Variant without transfer switch on board. ATS panel type QC as optional. The panel manages the QC panels directly or any other ATS panel.

### Mechanical features

Protection degree	IP	55
-------------------	----	----

### Battery charger

Model		ELCOS - CB1
Maximum output current	A	2,5
Output DC voltage (selectable)	Vdc	12-24
Input AC voltage (selectable)	Vac	220-260
Frequency	Hz	50-60

### Data Communication

Data connection port		RS-485
Communication protocol		Mod-bus RTU-8N1

### Remotable functions in terminal box

GS start	GS lock
Genset contactor close/open command (1)	Mains contactor close/open command (2)
Common Alarm - DC output	GS test without load
GS start with key in OFF position (Only in MRS mode)	Programmable output - Volt free output

## Control Module



Model	MC4
Operating mode	AMF - MRS

### Specifics

#### Applications

Emergency to the Mains  
Stand-alone  
Construction site/Rental  
Self-production

#### ENGINE MEASURES

Fuel tank level %  
Engine oil pressure BAR (1)  
Engine Coolant temperature °C (1)  
Total run time  
Partial run time  
Hours to maintenance  
Battery voltage  
Battery charging voltage  
Start-ups counter  
Engine speed (2)  
Engine Oil temperature (2)  
Cooler temperature (2)  
Engine oil level (2)  
Engine coolant level (2)  
Engine coolant pressure (2)  
Turbo pressure (2)  
Fuel Consumption (2)  
Tank autonomy - hrs (5)  
Fuel remaining quantity (5)  
Fuel used quantity (5)

#### ALTERNATOR MEASURES

Generator Voltage L1, L2, L3  
Generator Voltage L1-N, L2-N, L3-N  
Generator frequency  
Generator current L1, L2, L3  
Generator Apparent Power kVA  
Generator Active Power kW  
Generator Reactive Power kVAR  
Generator accumulated power kWh  
Power factor Cosφ

#### MAINS MEASURES

Mains voltage L1, L2, L3  
Mains voltage L1-N, L2-N, L3-N  
Mains frequency

#### COMMUNICATION PORTS

Can-bus port  
RS485 port with Mod-bus RTU communication  
RS232 port for display connection  
USB port for parameters saving and firmware update

#### EQUIPMENT

Microprocessor Logic  
Back-lit display  
Programmable from display  
16 event log  
Multiple display languages  
STOP button  
START button  
TEST button  
Reset alarm button  
Alarm mute button  
Fuel transfer pump activation button  
Glow-plug activation button

#### PRE-ALARMS/ ALARMS

Common Alarm  
Fuel reserve (pre-alarm)  
Low fuel level (alarm)  
Tank overflow  
Charge alternator failed (dinamo)  
Low oil pressure (pre-alarm) (1)  
Low oil pressure (alarm)  
Oil sensor failed (alarm)  
High coolant temperature (pre-alarm) (1)  
High coolant temperature (alarm)  
Low coolant temperature (pre-alarm)  
Low water level (1)  
Water in fuel (1)  
Battery undervoltage  
Battery overvoltage  
GS failure to start  
GS failure to stop  
Can-bus Failure  
No Can-bus communication  
Genset overload L1, L2, L3 phases  
Genset short circuit  
Genset overvoltage  
Genset undervoltage  
Genset high frequency  
Genset low frequency  
overspeed  
Reverse power  
Earth fault (pre-alarm)  
Earth fault (alarm)  
Block from password  
CAN communication Failed  
Maintenance request  
Emergency button pressed  
Remote emergency active  
Forced stop  
External battery failed  
Fuel theft  
Genset negative phase sequence  
Mains negative phase sequence  
Fuel theft protection

#### VISUALIZATIONS ON CONTROL MODULE/DISPLAY

Pre-alarms  
Alarms  
Engine measures  
Alternator measures  
Mains measures  
Date and time  
Operating mode  
Genset status  
Mains status  
Mains contactor status  
Genset contactor status  
Digital Input and Output status  
Grounding current mA (3)  
Grounding current threshold mA (3)  
Delay time of differential protection (3)  
Glow plugs status

#### CONTROL MODULE FUNCTIONS

Automatic start and stop when the Mains Fails (7)  
Remote Start and Stop  
Remote Start and Stop with key in OFF position  
Manual Start and stop  
Emergency stop button on panel board  
Remote emergency stop  
Remote lock  
Remote test without load  
Remote test on load  
Scheduled start-ups  
MODBUS commands (Start, Stop, Reset, Test)

#### CONTROL MODULE SPECIAL FUNCTIONS (on demand)

Automatic charging of an external battery  
Dummy load (4)  
Load shedding (4)  
Redundant starter motor management  
Fuel monitoring  
GS battery Load test  
Idle mode  
Service phone number indication  
Variable speed Generator  
Master / Slave mode

- (1) Present with the sensor installed on engine
- (2) Present according to the engine equipment and to the ECU type (ECU - Canbus)
- (3) Present only with the residual current device mounted on genset board
- (4) Present with optional expansion modules
- (5) Present with special function activated
- (6) Only with the optional of the automatic fuel refilling system on board
- (7) Only in AMF mode

AAABBB

## OPTIONAL

### Fuel Supply

**O.G-ACO-AT-C3V-02**

External fuel tank connections with 3-way valve for supply from internal or external tank (130/700 kVA)

**O.G-ACO-AT-C3V-AR-02**

Quick coupling connectors with 3-way valve for internal or external fuel tank connection (130/700 kVA)

**O.G-ACO-AT-CI-02**

External tank connections for supply only from external tank (g without tank) GE 130/700

**O.G-ACO-BT-C4100-1000**

1000 Lt Oversized Fuel Tank on board for SS, RB (275/400 kVA)

**O.G-ACO-BT-C4100-1900**

1900 Lt Oversized Fuel Tank on board for SS, RB (275/400 kVA)

**O.G-ACO-GA-01**

Mechanical analogue float for internal fuel tank on board

**O.G-ACO-GA-02**

Electrical analogue float to monitor the external refilling point on board

**O.G-ACO-RE-02**

External refilling point for Gen Sets 275/400 kVA, SS, RB versions

**O.G-ACO-RE-SP-02**

External refilling point with warning light for Gen Sets 275/800 kVA, SS, RB versions

**O.G-ACO-ST-2P**

Double redundant electric pump kit for automatic fuel refilling system

**O.G-ACO-ST-BG-ES1**

"Easy" automatic fuel refilling system on board, controlled by QPE-C and QLE-B panels

**O.G-ACO-ST-BG-HDT**

"Heavy Duty" automatic fuel refilling system on board, controlled by QPE-C and QLE-B panels

**O.G-ACO-ST-BG-STD**

"Standard" automatic fuel refilling system on board, controlled by QPE-C and QLE-B panels

### Alternator

**O.G-ALT-AL-CHBR-04**

Different brand alternator 275/400 kVA (Check dimensions)

**O.G-ALT-AL-COTE-01**

Temperature control unit up to 4 x PT100 probes for MC4 management

**O.G-ALT-ST-ACO-01**

Anti-condensation heater 230 V (on Stamford from 80 to 2000 kVA)

**O.G-ALT-ST-AVR-MX321**

Stamford MX321 automatic voltage regulator with PMG (Check dimensions)



**O.G-ALT-ST-AVR-MX341**

Stamford MX341 automatic voltage regulator with PMG (Check dimensions)



**O.G-ALT-ST-PT100-1CU**

1 x PT100 probe on bearing (80/3000 kVA)



**O.G-ALT-ST-PT100-3AV**

nr. 3 RTD-PT100 probes on stator windings (80/3000 kVA)



**O.G-ALT-ST-PT100-6AV**

nr. 3+3 RTD-PT100 probes on stator windings (80/3000 kVA)



**O.G-ALT-ST-RIGU-01**

Diode Failure Detector (DFD) mounted on the alternator. Alarm contact available into the panel

### ⚙ Batteries



**O.G-BAT-BAE-04**

Maintenance free high efficiency starter batteries (275/400 kVA)



**O.G-BAT-BNC-04**

24Vdc NiCd starter batteries (275/400 kVA)



**O.G-BAT-DOB-03**

Redundant battery kit for Gen Sets 275/400 kVA



**O.G-BAT-STB-02**

Battery isolator lockable(130/700 kVA)

### ⚙ Canopy



**O.G-COF-AM-02**

Hinges and Doors with tamper-proof device (130/400 kVA)



**O.G-COF-ANTI-RIL-01**

Fire detection kit for 20'/20' HC container, for machine room

**O.G-COF-ANTI-VALV-01**

Firewatchman thermal fuel cut off valve kit for immediate cutoff of the diesel flow in case of fire inside the canopy. Suitable only for stationary SS units from 300 to 750KVA



**O.G-COF-AP-01**

Door opening alarm system (each door)

**O.G-COF-C4100-INOX**

Additional cost for stainless steel canopy (C4100)



**O.G-COF-CA-C4100**

IP 43 Conveyors for Gen Sets 275/400 kVA - supplied disassembled



**O.G-COF-CH-07**

Additional cost for larger canopy C4700 instead of standard C4100 - Dim. cm 470x180x250H - Fuel tank 900 lt



**O.G-COF-DI-C4100**

Double soundproofing -2 dBA at 7 mt. (275/400 kVA) including IP43 conveyors (provided disassembled)





**O.G-COF-DLO-C4100-80KW** Dummy Load 80kW on board for Gen Sets 275/400 kVA



**O.G-COF-EAF-06** Frontal air expulsion for Gen Sets 275/400 kVA (C4100) - (change the noise level)



**O.G-COF-FP-02** Door stop (130/1000 kVA)



**O.G-COF-IL-02** Internal LED lighting with micro-switches for Gen Sets 275/700 kVA



**O.G-COF-PV-02** Lift off doors kit for SS versione (130/400 kVA) and PRO version (130/500 KVA)

**O.G-COF-TRT-MAR-04** High resistance canopy treatment for corrosive environments for 275/400 kVA (SS, RB Versions)



**O.G-COF-VER-PAR-04** Canopy custom paint (Grey base-frame) for 275/400 kVA (SS, RB Versions)



**O.G-COF-VER-TOT-04** Total canopy custom paint for 275/400 kVA (SS, RB Versions)

#### ⚙️ Container



**O.CO-GG-VE-01** Vertical gravity louvres for Ge 275/400 (for air outlet, double this and add also O.CO-GR-VE-ESP)

#### ⚙️ Electrical on board

**O.G-USP-AR-480** Powerlock connector 480A on board for SS Version

**O.G-USP-AR-750** Powerlock connector 750A on board for SS Version



**O.G-USP-MO-IN-EST** Switch panel with connection bars and cable entry, mounted on the canopy



**O.G-USP-MPT-03** 5-socket module installed on board, for Gen Sets SS +011 from 275 to 1100 kVA



**O.G-USP-MPT-04** 9-socket module installed on board, for Gen Sets SS +011 from 275 to 1100 kVA















**O.G-USP-SW-MOT.0275-0400** Motorization switch in switch panel on board machine for Ge from 275/400 Kva - (for variant +11)

**O.Q-QBM-BMIN-230V-02** Additional price for 230V minimum voltage coil on MCCB both on the control panel and on the alternator (check feasibility)

**O.Q-QBM-CPI-BEN-01** Permanent insulation controller for IT networks up to 230V / 400V. BENDER IR423-D4-1. Adjustable threshold  $10 \div 300$  kohm. (2 DIN rail modules - check feasibility)

**O.Q-QLE-K-DIF-M3** Adjustable differential protection only for MC2-PLUS controller for Gen Sets 10/500 kVA (+011 variant)



	<b>O.Q-QPA-COM-GC200</b>	Option with COMAP GC200 controller on board instead of DSE 8610.
	<b>O.Q-QPA-COM-GC500</b>	Option with COMAP GC500 controller on board instead of DSE 8610.
	<b>O.Q-QPA-COM-INTEL</b>	Option with COMAP INTELIGEN controller on board instead of DSE 8610.
	<b>O.Q-QPA-LOV-RGK900</b>	Option with LOVATO RGK900 controller on board instead of DSE 8610.
	<b>O.Q-QPE-485.CONV-LAN</b>	Converter 485/LAN for QPE-C, QLE-B panel
	<b>O.Q-QPE-485.CONV-USB</b>	Converter 485/USB for QPE panel
	<b>O.Q-QPE-DIS-MS.01</b>	MASTER/SLAVE device for QPE panel
	<b>O.Q-QPE-INT-CST-CTR-03</b>	STATUS and TRIP contact of main breaker wired to terminal board inside the QPE panel (275 / 1000KVA) on board (not for variant +010).
	<b>O.Q-QPE-K-DIF</b>	Differential protection adjustable for the MC4
	<b>O.Q-QPE-MD-QPE-C</b>	GSM remote management modem for QPE panel
	<b>O.Q-QPE-POT-VOLT</b>	Internal potentiometer for voltage regulation - available only for variant +10/+11
	<b>O.Q-QPE-PR-QPE-C</b>	Remote panel for QPE-C, QLE-B - available only for variant +10/+11
	<b>O.Q-QPE-QBM-COM-AMF25</b>	Option with QBM COMAP AMF25 controller on board instead of QPE
	<b>O.Q-QPE-QBM-DSE-7320</b>	Option with QBM DSE7320 controller on board instead of QPE.
	<b>O.Q-QPE-RIL-16RELE</b>	16-relay module for QPE panel
	<b>O.Q-QPE-RX8-QPE-C</b>	Start-stop radio control with max. radius 500 mt indoors and 5 km outdoors (for QPE panel).
	<b>O.Q-QPE-SAS-02</b>	Auto Start-Stop at load request (QPE, QLE panels)
	<b>O.Q-QPE-SCD-01</b>	Anti-condensation heater inside the panel
	<b>O.Q-QPE-SEL-50-60</b>	Switch selector 50Hz 400V / 60Hz 480V

**O.Q-QPE-TG-EVO-GPS-2G**

Remote management system via LAN/GSM 2G with WEB application and GPS location system

**O.Q-QPE-TG-EVO-GPS-3G**

Remote management system via LAN/GSM 3G with WEB application and GPS location system

**O.Q-QPE-TG-QPE-C**

Remote management software via LAN for QPE-C, QLE-B panel compatible with Windows XP and 7

**Engine**

**O.G-MOT-FC-7**

Dust collector filter - for Gen Sets 275/400 kVA

**O.G-MOT-FSA-7**

Fuel/Water Separator Filter - for Gen Sets 275/400 kVA

**O.G-MOT-K-40C-04**

Engine liquids suitable for -40°C ambient temperature for Gen Sets 275/400 kVA

**O.G-MOT-MAG-03**

Dual starter motor for Gen Sets 275/400 kVA (engine configuration to be checked)

**O.G-MOT-PO-02**

Oil change pump for Gen Sets 130/700 kVA

**O.G-MOT-SC-AC-EL-04**

Super hot engine heater 230V with thermostat on board for Gen Sets 275/700 kVA

**O.G-MOT-SC-AC-WE-02**

Webasto diesel-operated water pre-heater (130/400 kVA)

**O.G-MOT-SE-LR-02**

Radiator coolant level sensor from 130 to 700 kVA

**O.G-MOT-SRO-AU-50L**

Automatic oil refilling system (275/700 kVA)

**Handling**
**O.G-MOV-CN-6**

Off-road trailer with 2 pneumatic wheels and tow bar (SS, RB Gen Sets 275/400 kVA)

**O.G-MOV-CO-ST-06**

Roadworthy trailer 80km/h (275/400 kVA), registration excluded.

**O.G-MOV-KRM-SS-04**

Reinforcement kit for mobile installation (dedicated trailers or wheeled machinery) SS Version from 275 to 400 kVA

**ATS Panels**

**QC2.0630A**

Separate ATS panel, ABB 630A motorized change-over (430 kVA 400V - 250 kVA 230V) Dim. 60 x 50 x 160 cm - 125 kg. (ex QC2.400)

**QCP2.0630A**

Separate ATS switching panel, with Lovato ATL 610 control unit, for variant +014, ABB motorized change-over 630A 4P (430kva 400V) and compartment for power cables inlet

**Parallel panels**

**QP.APM3.0800A**

APM Automatic Parallel Module Comap IntelliVision5 logic with motorized breaker (800A) for gen set from 300kVA to 550kVA. Dim. cm. 60 x 60 x 190H.

**Exhaust**

**O.G-SCA-FAP-K400**

Particulate filter (DPF) for Gen Sets 350/400 kVA

**O.G-SCA-GF-120**

Exhaust bellow with flexible joint including flange and counter flange (275/700 kVA)

**O.G-SCA-PF-04**

Spark arrester for Gen Sets 275/400 kVA

**Test**

**MS.CP-LT-02**

FAT - Factory Acceptance Test for single Gen Set from 130 to 400 kVA according to our standard procedures in Elcos factory (max 2 hours - max 4 people - max 1 hour of operation)

**MS.CP-SP-02**

FAT - Factory Acceptance Test for single custom Gen Set from 130 to 400 kVA max 4 operating hours or parallel system up to 4 units for 1 operating hour, in Elcos factory (max 4 hours - max 4 people )

**MS.CP-ST-02**

FAT - Factory Acceptance Test for single Gen Set from 130 to 400 kVA according to our standard procedures in Elcos factory (max 4 hours - max 4 people - max 2 hour of operation)

**MS.RF-ST-02**

Noise test report for single Gen Set from 250 to 700 kVA

**MS.TV-ST-02**

Vibration test on 10 points with certificate for single Gen Set from 275 to 3000 kVA

**Vari**

**O.G-VAR-CAT-02**

Toolbox for ordinary maintenance.

**O.G-VAR-PUN-TER-01**

Round earth spike, diam. 20 mm, height 1.5mt, galvanized, complete with clamp and 3m yellow/green cable model FS17 1x35mm<sup>2</sup> with cable lugs.

**O.G-VAR-PUN-TER-02**

Cross-shaped earth spike, height 1.5mt, galvanized, complete with clamp and 3m yellow/green cable model FS17 1x35mm<sup>2</sup> with cable lugs.

**O.G-VAR-TPD-01**

IP 55 document holder

**PRP**

Engines of this rating provide unlimited hours of usage in a variable load application. The average load factor should not exceed 70% of the engine's prime power rating with a maximum number of 500 operational hours at 100% prime power rating. An overload capability of 10% is available, however, is limited to a period of 1 in every 12 hours

**LTP**

Limited-time running power is defined as the maximum power available, under the agreed operating conditions, for which the generating set is capable of delivering for up to 500h of operation per year with the maintenance intervals. The overload is not allowed.

Sheet:	C 4100	SUPER SILENT	Exhaust side:	-	Type:	STANDARD	Rev:	01	Last Update:	Oct 14, 2019	Page 1/2
--------	--------	--------------	---------------	---	-------	----------	------	----	--------------	--------------	----------

### OVERALL DIMENSIONS [mm]

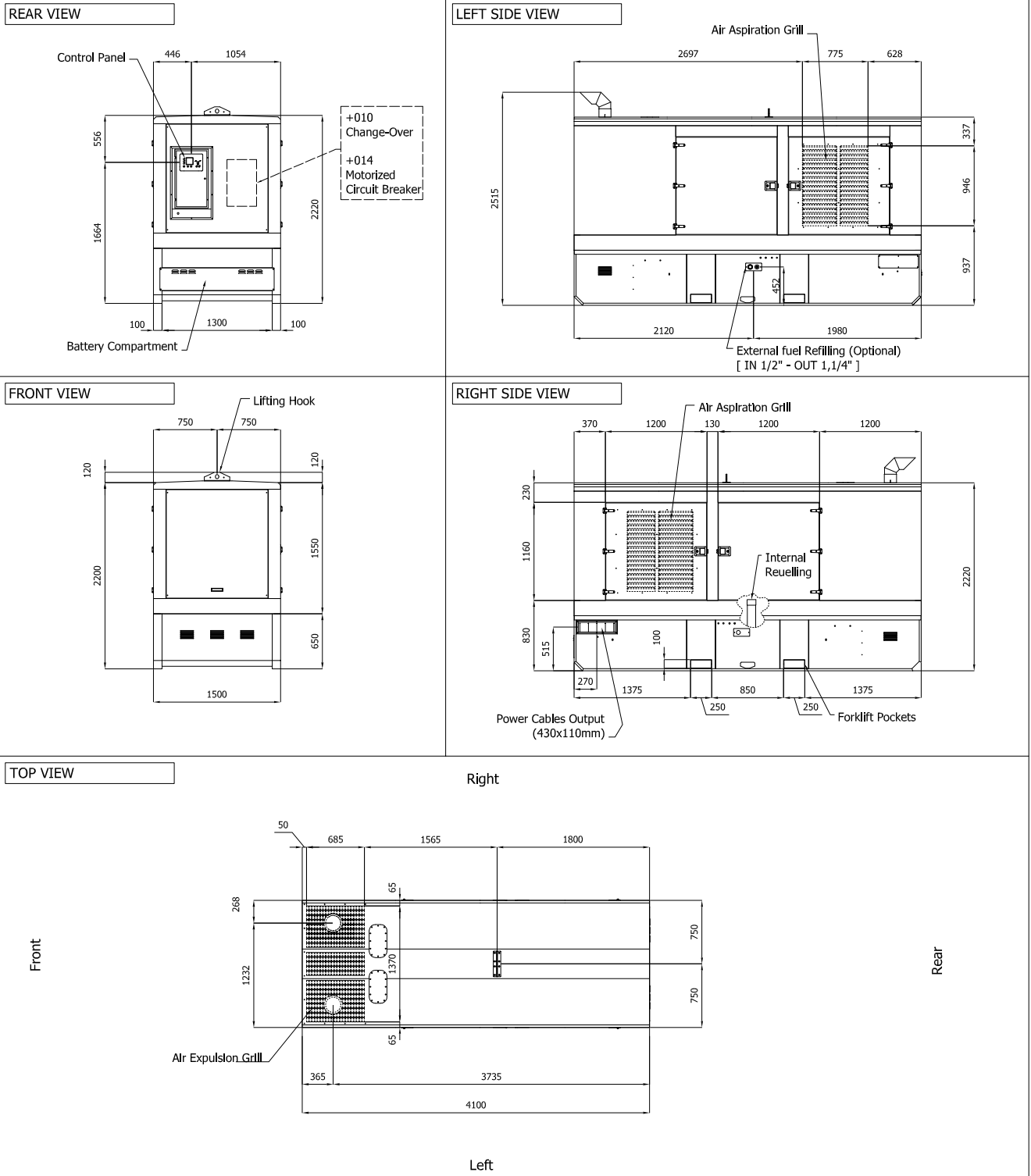

### VENTILATION OF THE ROOM

The windows area in the generating set room needs to be (recommended):  
 Aspiration: 1.50 m<sup>2</sup>  
 Expulsion: 1.00 m<sup>2</sup>  
**ATTENTION:** for a correct ventilation the expulsion air and the exhaust gas needs to be conveyed in the open-air

- IMPORTANT:**
- 1) Form and dimension refer to the generating set on catalogue
  - 2) Form and dimension are subject to change in order to update or improve the products
  - 3) This document can not be copied or transmitted without ELCOS S.r.l. approval

Sheet:	C 4100	SUPER SILENT	Exhaust side:	-	Type:	STANDARD	Rev:	01	Last Update:	Oct 14, 2019	Page 2/2
--------	--------	--------------	---------------	---	-------	----------	------	----	--------------	--------------	----------

**BOTTOM VIEW**

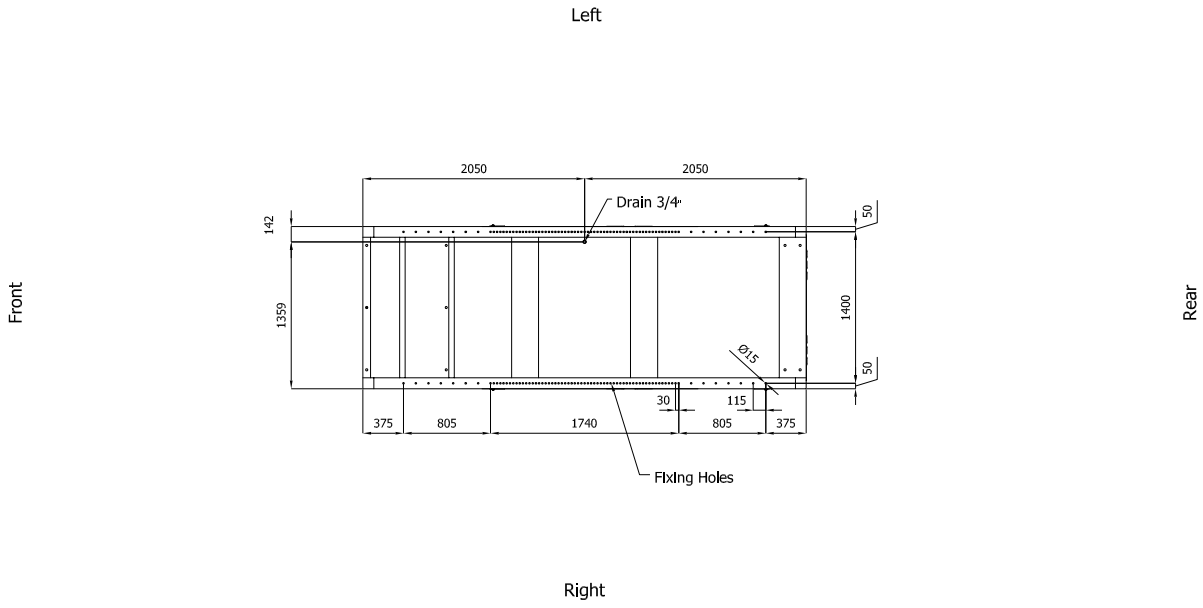

**DIMENSIONS WITH OPEN DOORS [mm]**

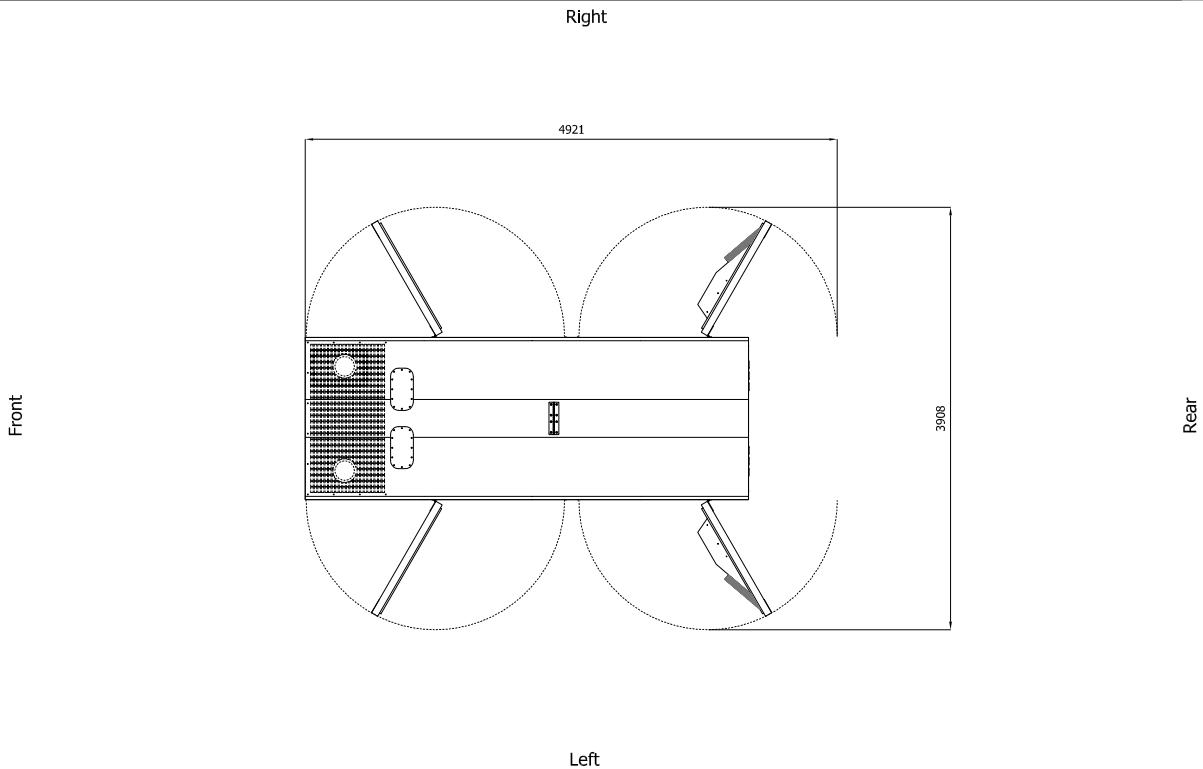

Note: -With Lifting-Off Door Solution consider only canopy dimensions.

- IMPORTANT:**
- 1) Form and dimension refer to the generating set on catalogue
  - 2) Form and dimension are subject to change in order to update or improve the products
  - 3) This document can not be copied or transmitted without ELCOS S.r.l. approval